

AC INFINITY

CONTROLLER 69

USER MANUAL

WELCOME

Thank you for choosing AC Infinity. We are committed to product quality and friendly customer service. If you have any questions or suggestions, please don't hesitate to [contact](#) us. Visit www.acinfinity.com and click contact for our contact information.

EMAIL

support@acinfinity.com

WEB

www.acinfinity.com

LOCATION

Los Angeles, CA

MANUAL CODE CTR692108X2

PRODUCT

CONTROLLER 69

MODEL

CTR69A

UPC-A

819137022652

FAN COMPATIBILITY

This controller is natively compatible with AC Infinity devices with UIST™ connectors. Older model inline fans with EC motors may be used with this controller using a Molex adapter. An EC-motor fan will have two cords coming out of its motor box for the power and the controller. Note that certain models that previously used DC-motors now contain EC-motors in updated builds.

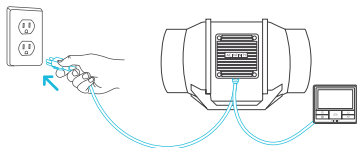

EC Motor - Compatible

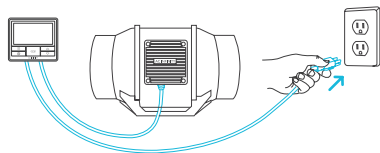

AC or DC Motor - NOT Compatible

Please visit www.acinfinity.com to check for the latest models compatible with this controller.

MANUAL INDEX

Compatibility	Page 4
Manual Index	Page 5
Key Features	Page 6
Product Contents	Page 7
Powering and Setup	Page 8
Controller Mounting	Page 10
Adding More Devices	Page 12
Universal Infinity System	Page 14
UIS Compatibility	Page 15
Programming	Page 16
Other Settings	Page 31
Download the App	Page 32
Add a Device	Page 33
App Programming.....	Page 36
App Settings.....	Page 47
FAQ.....	Page 49
Other AC Infinity Products	Page 50
Warranty	Page 51

KEY FEATURES

SMART CONTROLLER

Features automation controls that activate your devices based on climate conditions, timers, and schedules.

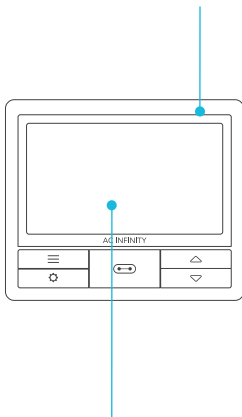

ACTIVE MONITORING

LCD display shows key data like temperature, humidity, device levels, trends, time, countdowns, and more.

VERSATILE PLACEMENT

Mount the controller on a steel surface using the rear magnet or open the kickstand to sit it tilted on your desktop.

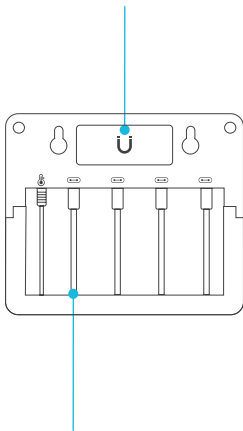

UIS CONNECTIVITY

Connect up to four devices to simultaneously set programming for all devices or independently for each device.

APP-CONTROLLED

Bluetooth-enabled to connect with the AC Infinity app for access to smart automations, climate data, and history logs.

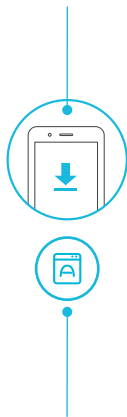

ADVANCE SETTINGS

Additional setting options include Fahrenheit/Celsius toggling, clock, calibrations, and custom transitions.

PRODUCT CONTENTS



SMART
CONTROLLER
(x1)

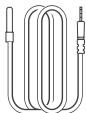

SENSOR
PROBE
(x1)

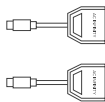

UIS M - 4PIN F
ADAPTER
(x2)



WOOD SCREWS
(WALL MOUNT)
(x2)



WOOD SCREWS
(WALL HANG)
(x2)

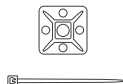

WIRE
TIE
(x1)

POWERING AND SETUP

STEP 1

Plug your device's UIS connector into one of the controller's ports.

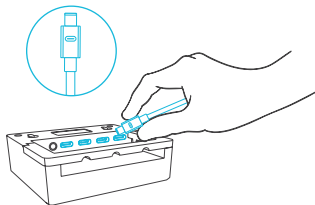

STEP 2

Plug the sensor probe into the controller's 3.5mm jack. Set the probe near your plants in your grow tent for the most accurate reading.

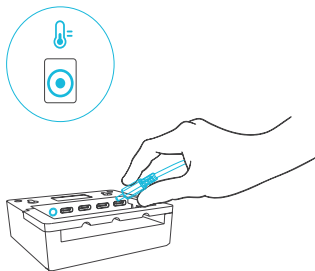

POWERING AND SETUP

STEP 3

Plug your device's power cord into an AC power outlet to power it and the controller.

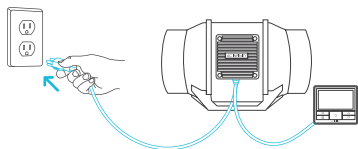

STEP 4

You may use the included tie mounts, wood screws, and zip ties to cable manage the cords.

Secure the tie mounts onto a surface using the wood screws. Loop the zip ties around the cords into the tie mounts.

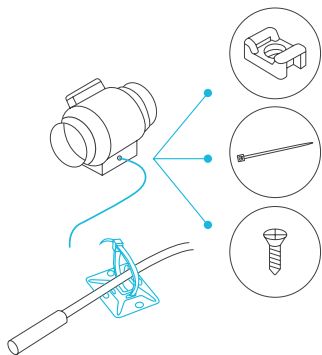

CONTROLLER MOUNTING

STEP 1

Locate a spot free of obstruction and secure the anchors into your wall. Twist the wood screws into the anchors.

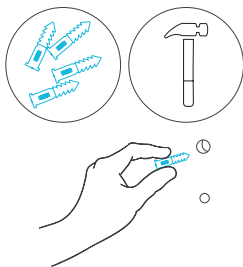

STEP 2(a)

Hang the controller by the screws using the holes on the backside.

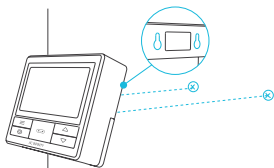

You may also mount the controller using the magnet located behind the label.

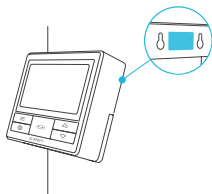

CONTROLLER MOUNTING

STEP 2(b)

Cords may be routed into or outside of the kickstand grooves, and through a cut hole behind the controller.

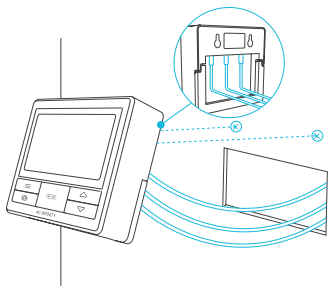

KICKSTANDING

Open the stand behind the controller to set it tilted on your desktop.

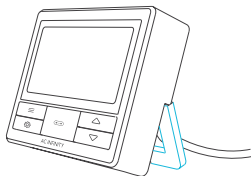

ADDING MORE DEVICES

The CONTROLLER 69 is built with four ports that enable you to power and control multiple fans at the same time. See image below for a sample configuration.

Multi-Fan Connection

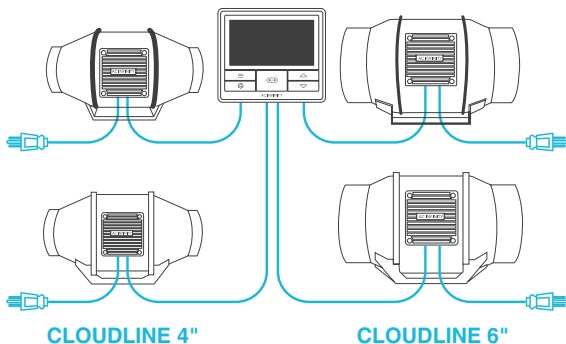

EXPANSION DONGLE

The expansion dongle will allow you to connect 2 or 4 devices with a single port and can support additional dongles to create more expansion ports (up to 64 units supported with the use of 20 dongles*). Intended for exclusive use with AC Infinity controllers built with UIS ports.

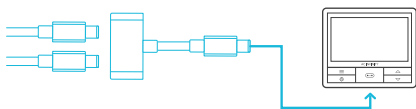

*UIS extension cord and dongle sold separately

ADDING MORE DEVICES

The CONTROLLER 69 is built with four ports that enable you to power and control multiple grow lights at the same time. See image below for a sample configuration.

Multi-Light Connection

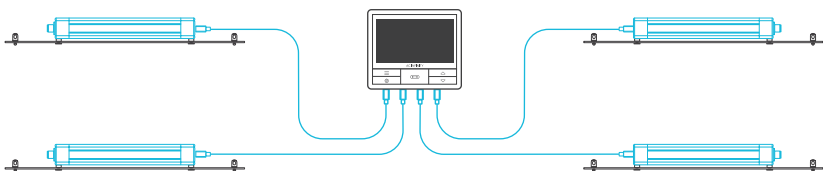

EXPANSION DONGLE

The expansion dongle will allow you to connect 2 or 4 devices with a single port and can support additional dongles to create more expansion ports (up to 64 units supported with the use of 20 dongles*). Intended for exclusive use with AC Infinity controllers built with UIS ports.

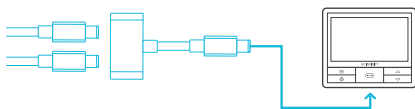

*UIS extension cord and dongle sold separately

UNIVERSAL INFINITY SYSTEM

The Universal Infinity System™ enables you to connect a single central controller with several grow devices simultaneously. By creating this fully integrated system, you can power and program all your devices together or separately for optimized grow tent management.

Use select smart controllers to set triggers that will activate your devices based on your grow tent's temperature and humidity. Create independent timers and schedules for customized activation in your desired timeframe.

Your grow system can be regulated using your controller hub or remotely on the AC Infinity app (paired with compatible controllers), where you will have access to automation programming and climate data.

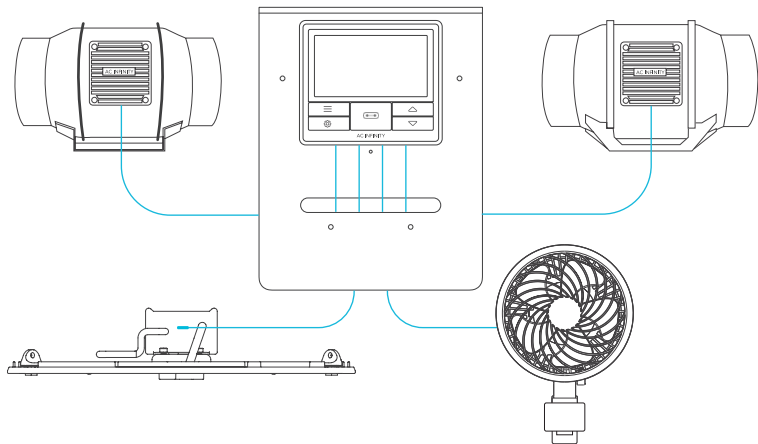

Central controllers and grow devices will be sold separately and may still be in development at the time of your purchase of this product.

UIS COMPATIBILITY

MOLEX ADAPTER

Use the included Molex adapter to plug inline fans with 4-pin Molex connectors into this controller. Plug your fan's Molex connector into the adapter. Then plug the adapter into the controller.

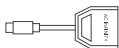

UIS M - 4PIN F
ADAPTER

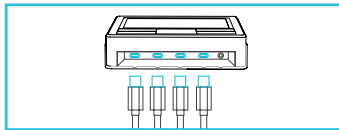

EXTENSION CABLE

Use male-to-male UIS extension cords to connect devices with female UIS ports at an extended range from your controller.

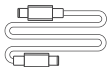

UIS M - M
CORD

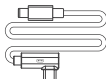

UIS M - M
CLIP FAN CORD

EXPANSION DONGLE

The expansion dongle will allow you to connect 2 or 4 devices with a single port and can support additional dongles to create more expansion ports (up to 64 units supported with the use of 20 dongles*). Intended for exclusive use with AC Infinity controllers built with UIS ports.

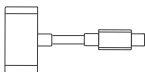

UIS M - M
2 PORT DONGLE

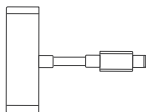

UIS M - M
4 PORT DONGLE

*UIS extension cord and dongle sold separately

PROGRAMMING

1. PORT BUTTON

Cycles through up to four connected devices. Each device is programmed independently, or together when navigating to ALL.

4. UP/DOWN BUTTONS

Adjusts the value of your current mode. The up button increases and down button decreases the setting. Hold both to reset values to OFF or 0.

6. PROBE TEMP.

Displays the current temperature that the probe is detecting. Shows "--" if no probe is plugged in. Includes a trend indicator that signals a rise, steady, or fall in temperature within the last hour.

8. CONTROLLER MODE

Displays the controller's current mode. Pressing the mode button cycles through the available modes.

11. CURRENT LEVEL

Displays the connected devices' current setting. Includes a trend indicator that signals if the setting is currently rising, falling, or holding steady.

2. MODE BUTTON

Cycles through the controller's modes: OFF, ON, AUTO (4 triggers), TIMER to ON, TIMER to OFF, CYCLE (ON and OFF), and SCHEDULE (ON and OFF).

3. SETTING BUTTON

Cycles through the controller's settings: DISPLAY, CLOCK, °F/°C, CALIB. T°/H%, and TRANS. T°/H%.

5. PORTS

Displays all connected devices as well as their current level. Digits are displayed by the UIS symbol when a device is plugged into its corresponding port.

7. PROBE HUMIDITY

Displays the current humidity that the probe is measuring. Shows "--" if no probe is plugged in. Includes a trend indicator that signals a rise, steady, or fall in humidity within the last hour.

10. CURRENT TIME

Displays the current time. The internal battery sustains the clock so it does not default to 00:00 if power is cut off.

13. USER SETTING

Displays the value of your current mode. Use the up or down buttons to adjust the value.

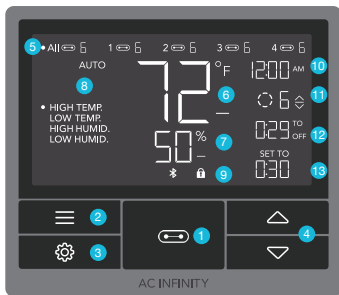

9. ALERT ICONS

Displays alerts and statuses of the controller, including the controller lock, CLIMATE alert, and TIMER alert.

12. COUNTDOWN

Displays the countdown of the TIMER TO ON, TIMER TO OFF, CYCLE, or SCHEDULE mode activates or deactivates the devices. TO ON shows the amount of time left before the devices turn on. TO OFF shows the amount of time left before the device turn off.

PROGRAMMING

PORTS

Pressing the port button will cycle through the controller's available ports: ALL, 1, 2, 3, and 4. Dot indicates the current device. No digit is displayed if a device is not plugged into the corresponding port.

ALL PORTS

Navigate to the ALL port to set simultaneous programming for all connected devices.

Programming set in this port mode applies to all connected devices, but will not be active if you navigate to other ports. Re-entering the ALL port will resume its programming.

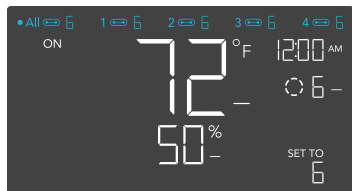

INDIVIDUAL PORT

Navigate to a numbered port with a connected device to set individual programming.

Programming will run in the background even while you navigate to other numbered ports.



PROGRAMMING

CONTROLLER MODES

Pressing the mode button will cycle through the controller's available programming modes: OFF, ON, AUTO (4 triggers), TIMER TO ON, TIMER TO OFF, CYCLE (On and Off), and SCHEDULE (On and Off).

OFF MODE

Your devices will not run while in this mode.

The level set while in this mode establishes the minimum level in other modes. When the devices are triggered to turn OFF in all other modes, they will instead run at the level set here.



ON MODE

Your devices will actively run at the level set here, regardless of the probe's reading. The ON mode also serves as the maximum level setting the other modes will run in.



PROGRAMMING

AUTO MODE (HIGH TEMPERATURE TRIGGER)

Pressing the up or down button sets the high temperature trigger. The devices will activate if the probe's reading meets or exceeds this threshold.

Once triggered, the devices will gradually ramp up to the level set in ON mode. If the probe's reading falls below this trigger point, the devices will gradually slow down to a stop or at the level set in OFF mode.

You may set this trigger below the low temperature trigger to create a specific range in which the devices are active.

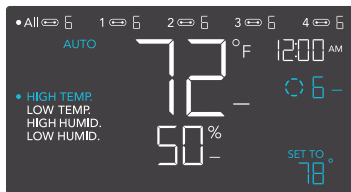

Note that this trigger can activate as long as you are in AUTO Mode, even if you are viewing a different trigger within AUTO Mode.

If there is a level set in OFF Mode other than zero, the devices will run at that level when triggered to turn off.

AUTO MODE (LOW TEMPERATURE TRIGGER)

Pressing the up or down button sets the low temperature trigger. The devices will activate if the probe's reading meets or falls below this threshold.

Once triggered, the devices will gradually ramp up to the level set in ON mode. If the probe's reading rises above this trigger point, the devices will gradually slow down to a stop or at the level set in OFF mode.

You may set this trigger above the high temperature trigger to create a specific range in which the devices are active.

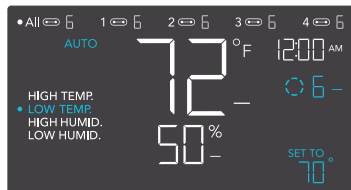

Note that this trigger can activate as long as you are in AUTO Mode, even if you are viewing a different trigger within AUTO Mode.

If there is a level set in OFF Mode other than zero, the devices will run at that level when triggered to turn off.

PROGRAMMING

AUTO MODE (HIGH HUMIDITY TRIGGER)

Pressing the up or down button sets the high humidity trigger. The devices will activate if the probe's reading meets or exceeds this threshold.

Once triggered, the devices will gradually ramp up to the level set in ON mode. If the probe's reading falls below this trigger point, the devices will gradually slow down to a stop or at the level set in OFF mode.

You may set this trigger below the low humidity trigger to create a specific range in which the devices are active.

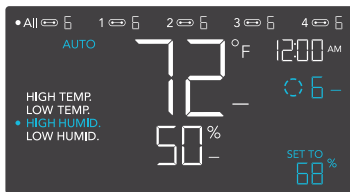

Note that this trigger can activate as long as you are in AUTO Mode, even if you are viewing a different trigger within AUTO Mode.

If there is a level set in OFF Mode other than zero, the devices will run at that level when triggered to turn off.

AUTO MODE (LOW HUMIDITY TRIGGER)

Pressing the up or down button sets the low humidity trigger. The devices will activate if the probe's reading meets or falls below this threshold.

Once triggered, the devices will gradually ramp up to the level set in ON mode. If the probe's reading rises above this trigger point, the devices will gradually slow down to a stop or at the level set in OFF Mode.

You may set this trigger above the high humidity trigger to create a range in which the devices are active.

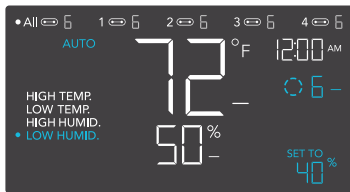

Note that this trigger can activate as long as you are in AUTO Mode, even if you are viewing a different trigger within AUTO Mode.

If there is a level set in OFF Mode other than zero, the devices will run at that level when triggered to turn off.

PROGRAMMING

TIMER TO ON MODE

Pressing the up or down button sets a countdown time. Once the timer ends, the devices will trigger to run at the level set in ON Mode. If there is a level set in OFF Mode, the devices will run at that level during the countdown.

The countdown will begin if no buttons are pressed for 5 seconds. The time left on the countdown is displayed below the current level. Leaving the timer mode while the countdown is running will pause it until you return to this mode.



If there is a level set in OFF Mode other than zero, the devices will run at that level when triggered to turn off.

TIMER TO OFF MODE

Pressing the up or down button sets a countdown time. The devices will run at the level set in ON Mode until the countdown ends. If there is a level set in OFF Mode, the devices will run at that level after the end of the countdown.

The countdown will begin if no buttons are pressed for 5 seconds. The time left on the countdown is displayed below the current level. Leaving the timer mode while the countdown is running will pause it until you return to this mode.



If there is a level set in OFF Mode other than zero, the devices will run at that level when triggered to turn off.

PROGRAMMING

CYCLE MODE (ON AND OFF)

Set an on duration and an off duration for the devices to cycle through continuously. Press the up or down button to first set a duration for the devices to activate. Then press the mode button again and set a duration for the devices to deactivate.

When the devices are activated, they will run at the level set in ON Mode. When the devices are deactivated, they will run at the level set in OFF Mode.

The countdown will begin if no buttons are pressed for 5 seconds. The time left on the countdown before the next ON or OFF phase is displayed below the current level. Leaving the cycle mode while the countdown is running will pause it until you return to this mode.

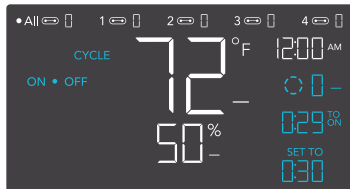
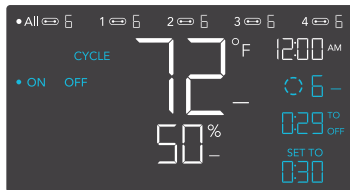

If there is a level set in OFF Mode other than zero, the devices will run at that level when triggered to turn off.

PROGRAMMING

SCHEDULE MODE (ON AND OFF)

Sets an on clock-time and an off clock-time schedule for the devices to follow daily. Press the up or down button to first set up an on clock-time to trigger ON mode, then press the mode button to set an off clock-time to trigger OFF mode. Please be sure to set the current clock time under settings.

When the devices are triggered to activate, they will run at the level set in ON Mode. When the devices are triggered to deactivate, they will run at the level set in OFF Mode.

The countdown will begin if no buttons are pressed for 5 seconds. The time left on the countdown before the next on or off phase is displayed below the current level. The devices will not follow this schedule if you leave this mode. If you re-enter the Schedule Mode, they will continue to follow the latest schedule you have set.

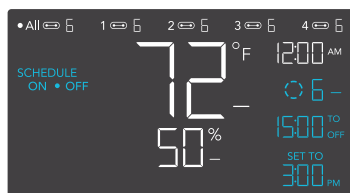
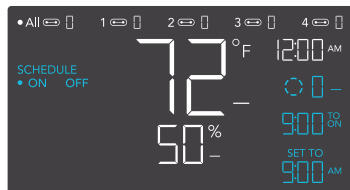

If there is a level set in OFF Mode other than zero, the devices will run at that level when triggered to turn off.

PROGRAMMING

CONTROLLER SETTINGS

Pressing the setting button will cycle through the controller's available settings: DISPLAY, °F/°C, CLOCK, CALIB. T°, CALIB. H%, TRANS. T°, and TRANS. H%.

DISPLAY SETTING

Adjusts the display brightness and auto-dimming. Press the up or down button to cycle through levels 1, 2, 3, A2 and A3; 3 being the highest brightness setting, while 1 is the lowest. In settings 1, 2 and 3, the display will stay at that brightness level and will not automatically dim the display.

A2 and A3 will set the brightness level at 2 and 3, respectively, and will dim down the brightness level 1 when the controller is not being used after 15 seconds.



TOGGLING THE DISPLAY

Lock the controller by holding the setting button.

Press the setting button to turn the display off. Pressing the setting button again will turn the display back on.

Programs will still run in the background while the LCD screen is off.

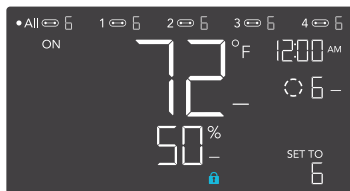

PROGRAMMING

°F/°C SETTING

Changes the displayed units to Fahrenheit or Celsius. Press the up or down button to cycle through F and C. All displayed units will automatically convert when adjusting this setting.

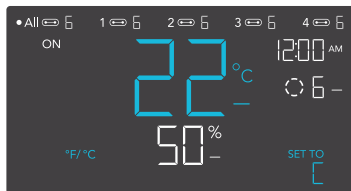

CLOCK SETTING

Adjusts the current clock time. Press the up or down button to increase or decrease the time. Once you cycle through 12:00 each time, the units will automatically change to AM or PM. The clock time is located at the top right corner of the display.



PROGRAMMING

CALIBRATION TEMPERATURE SETTING

Adjusts the temperature reading the sensor probe is measuring. Press the up or down button to increase or decrease the data figure in 2°F (or 1°C) increments. The calibration cycle ranges from -20°F to 20°F (or -10°C to 10°C) and will be applied to the sensor probe's measurements.

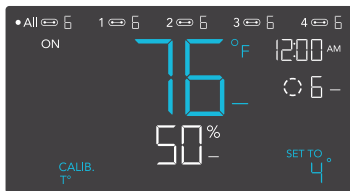

CALIBRATION HUMIDITY SETTING

Adjusts the relative humidity reading the sensor probe is measuring. Press the up or down button to increase or decrease the data figure in 1% increments. The calibration cycle ranges from -10% to 10% and will be applied to the sensor probe's measurements.

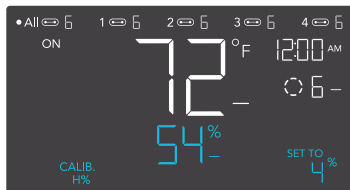

PROGRAMMING

TRANSITION TEMPERATURE SETTING

Adjusts the transition threshold between the levels in the AUTO Mode temperature triggers.

Press the up or down button to cycle through 0°F to 8°F (0°C to 4°C) and set a transition threshold. The level will be set one level above the OFF Mode level when the sensor temperature first meets or exceeds the high temperature trigger. For every transition threshold crossed, the level will ramp up by one level, up until it reaches the level set in ON Mode.

In this example, your high temperature trigger is set at 80°F, the OFF Mode level is 0, and the ON Mode level is 6. If the transition threshold is set to 0°F, then the devices will trigger to run at level 6 when the sensor temperature meets or exceeds 80°F. However, if the transition threshold is set to 2°F, then the devices will trigger to run at level 1 when it meets or exceeds 80°F. It will then step up to level 2 when meeting or exceeding 82°F, level 3 at 84°F, level 4 at 86°F, and level 5 at 88°F. From 90°F on, it will run at level 6, the level set in ON Mode.

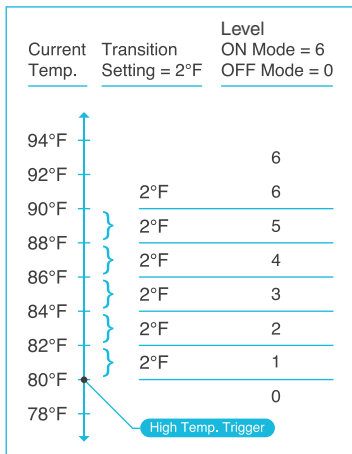
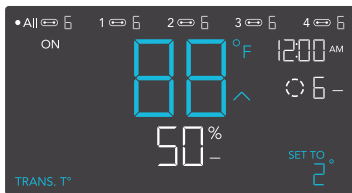

PROGRAMMING

TRANSITION HUMIDITY SETTING

Adjusts the transition threshold between the levels in the AUTO Mode humidity triggers.

Press the up or down button to cycle through 0% to 8% to set a transition threshold. The level will be set one level above the OFF Mode level when the sensor humidity first meets or exceeds the high humidity trigger. For every transition threshold crossed, the level will ramp up by one level, up until it reaches the level set in ON Mode.

In this example, your high humidity trigger is set at 67%, the OFF Mode level is 2, and the ON Mode level is 7. If the sensor humidity meets or exceeds 67%, then the devices will trigger to run at level 7 when the sensor humidity meets or exceeds 67%. However, if the transition threshold is set to 5%, then the fan will trigger to run at level 3 when it meets or exceeds 67%. It will then step up to level 4 when meeting or exceeding 72%, level 5 at 77%, and level 6 at 82%. From 87% on, it will run at level 7, the level set in ON Mode.

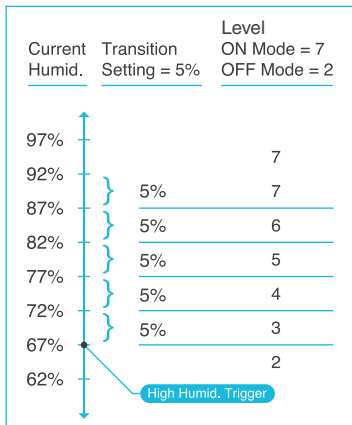
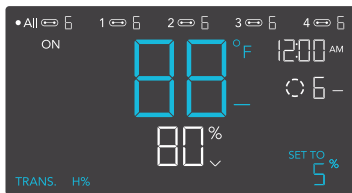

PROGRAMMING

ALERT ICONS

The alert icons are displayed at the top of the screen. Icons may flash when the controller signals an alert to notify you of any triggered function or alarm.

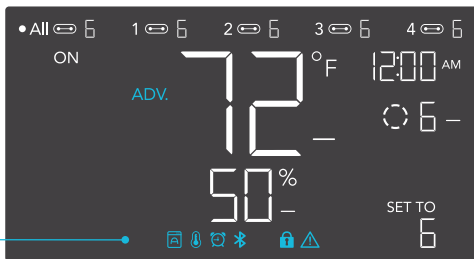

ADVANCE PROGRAMMING

Displays when an advance program set in the app is active. "ADV." will appear and override the controller if an automation program is in use.



AUTO MODE ALERT

Flashes whenever any of the auto mode triggers (high temperature, low temperature, high humidity, or low humidity) activate your devices.



TIMER ALERT

Flashes when a countdown has completed for TIMER TO ON, TIMER TO OFF, CYCLE, or SCHEDULE Mode.

PROGRAMMING

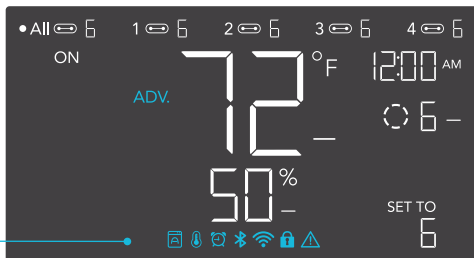

BLUETOOTH

Appears when the physical controller is connected to the app via Bluetooth.



DISPLAY LOCK ALERT

Displays when you lock the controller. The icon will flash and beep if you attempt to adjust the controller while it is still locked.



TEMPERATURE/ HUMIDITY ALARM

Flashes and beeps with alarm if the temperature/ humidity meet the trigger point set in the app.

OTHER SETTINGS

FACTORY RESET

Holding the mode, up, and down buttons together for 5 seconds will reset your controller and restore factory settings. This clears all user parameters in each controller mode and setting.



CONTROLLER LOCK

Holding the setting button will lock the controller in your current mode. While your controller is locked, no parameters may be adjusted, nor will you be able to switch modes. Holding the setting button again will unlock the controller.



HIDE SCREEN

Lock the controller so no settings can be adjusted. See above. Then press the setting button to turn the display off. Pressing it again will turn the display back on. Programs will still run in the background while the LCD screen is off.



JUMP TO OFF MODE

Holding the mode button for 3 seconds while in any mode or setting will automatically jump to OFF Mode. This function is disabled if the controller is locked.



RESET TO OFF OR ZERO (0)

Holding the up and down buttons together for 2 seconds will reset the value of your current mode to OFF or 0. Pressing either the up or down button will return the value to the mode's last setting.



AUTO INCREASING OR DECREASING

Holding the up or down button will increase or decrease the user setting automatically until you release them.



DOWNLOAD THE APP

THE AC INFINITY APP

The AC Infinity app enables you to connect with the next generation of our intelligent controllers, giving you access to advance programs and environmental data.

1

Download the AC Infinity app from the App Store or Play Store.



2

Open the AC Infinity app. Follow the instructions in the app to pair your controller with the app.



3

Scan the QR code below or visit our website at www.acinfinity.com for more information on the AC Infinity app.



ADD A DEVICE

1

Connect the devices and probe into your controller. Plug the devices into a wall outlet.

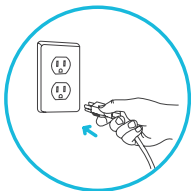
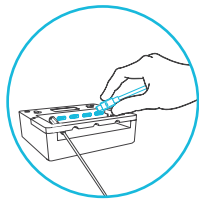

2

Launch the app. Tap the (+) button, then "SMART CONTROLLERS"

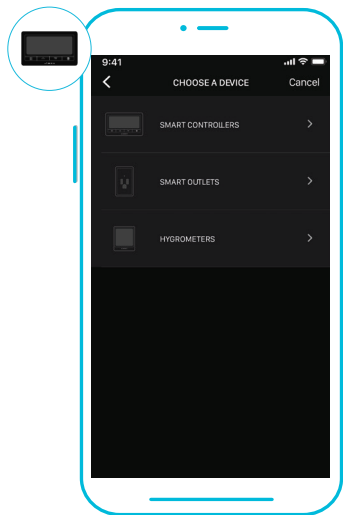

Please note: Bluetooth must be enabled on your mobile device before starting the pairing process.

ADD A DEVICE

3

Select CONTROLLER 69 to begin pairing.

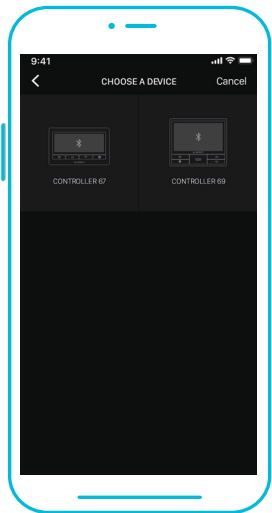

4

Hold the port button for 5 seconds to activate Bluetooth. Wait for the Bluetooth icon to start flashing on your controller's screen.



ADD A DEVICE

5

Tap DONE button to complete the pairing process.

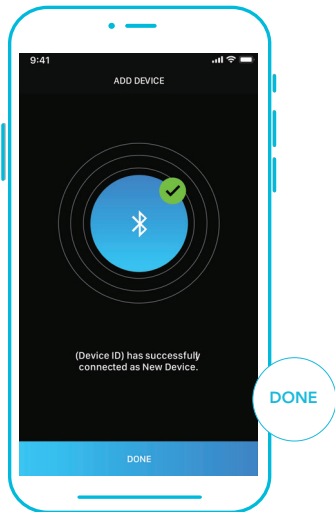

6

Your controller will appear in your smart device with a unique ID.

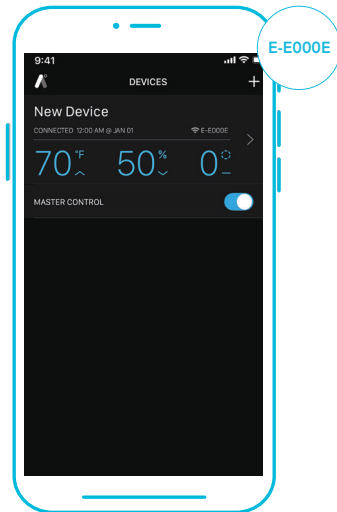

Please note: When pairing the app around multiple controllers, move your mobile device closer to your desired controller.

APP PROGRAMMING

DEVICE PAGE

Your controller will appear in your device page. Use the MASTER CONTROL toggle button to switch between the ALL port and the individual numbered ports. Your devices will share the same programming when navigating to the ALL port, or have independent programming when switching to the numbered ports.

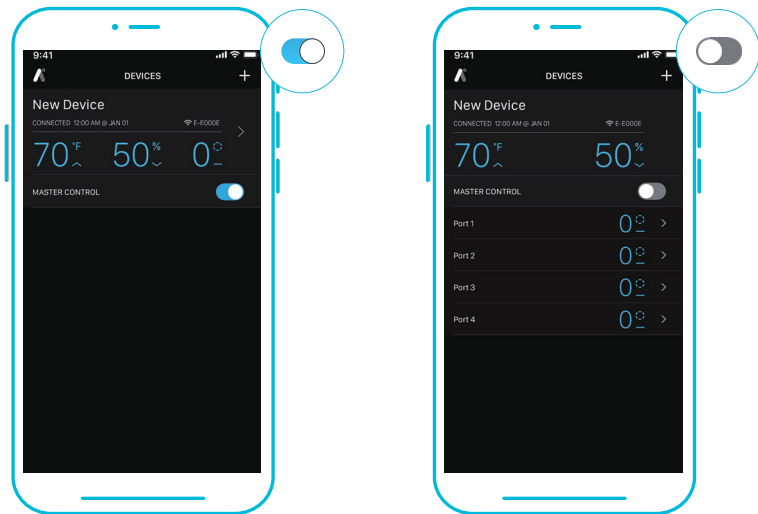

APP PROGRAMMING

1. MODE BUTTON

Dropdown displays all available controller modes: OFF, ON, AUTO, TIMER TO ON, TIMER TO OFF, CYCLE, and SCHEDULE.

4. CONNECTION STATUS

Displays the last time and date the app is paired with the controller and whether or not they are currently connected.

6. SLIDERS

Adjusts the setting of your current mode. Slide left to decrease and slight right to increase. The (+/-) steppers may also be used.

8. ADV. PROGRAMMING

Creates automated activations, alarms, and push notifications.

10. HISTORY LOG

Logs all advance programming notifications and controller activity. Can be filtered by controller functions.

2. TEMPERATURE/HUMIDITY

Toggles between current temperature and humidity readings.

3. SETTINGS

Adjusts app settings including Device Name, Temperature Display, Device Brightness, Transitions, and Calibrations.

5. CONTROL WHEEL

Lays out your current mode's controls and displays temperature/humidity, current settings, and clock.

7. CONTROLS TAB

Gives access to the controller mode dashboard, control wheel, mode button, temperature/humidity button, and sliders.

9. DATA TAB

Logs and stores all temperature and humidity information. Tracks trends and distribution. Data can be sorted by hour, day, week, month, and year.

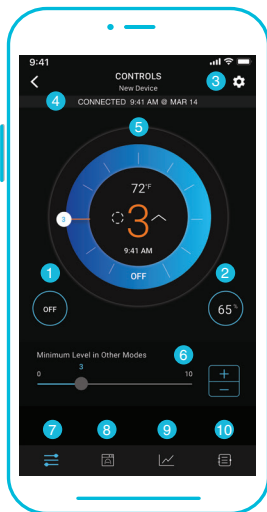

APP PROGRAMMING

CONTROLS TAB

Contains all controller modes including the OFF, ON, AUTO, TIMER TO ON, TIMER TO OFF, CYCLE and SCHEDULE modes.

1

Tap the paired device to enter the Controls tab, where you can adjust the controller modes.

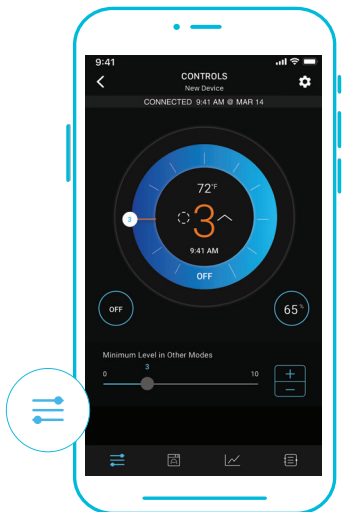

2

Tap the menu button to access the controller modes. Tap the temperature/humidity button to switch between readings.

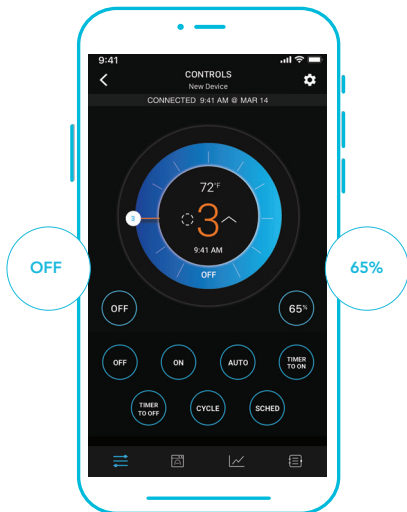

APP PROGRAMMING

CONTROLS TAB

The control wheel displays the temperature/humidity, current settings, and time.

3

Use the wheel hands, (+/-) stepper, or sliders to set your parameters.

4

Use the toggle switch to activate or deactivate any climate triggers.



APP PROGRAMMING

ADVANCE PROGRAMMING

Creates automated activations, alarms, and push notifications. The adjustable modes in each program include those listed in controls tab.

Once an advance program completes its programming (i.e. scheduling), the app will no longer override the controller's onboard settings. Only when the advance program activates will the app override the controller.

Programs can be edited by tapping on them, deactivated by tapping on the toggle switch, or deleted by swiping right and tapping DELETE.

All activity is logged in the History Logs tab.

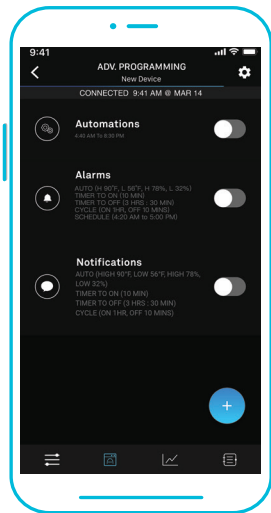

APP PROGRAMMING

ADVANCE PROGRAMMING - AUTOMATION

Each automation can support one mode at a time. To automate multiple modes, you must create additional programs, except for TIMER TO ON and TIMER TO OFF in automation. The app will override the controller while an automation is active.

1

Tap the (+) button to create an automation program.

Set a start time and end time using the time picker. Then select your desired mode to trigger. Choose between ON mode, OFF mode, CYCLE mode, or Temperature and Humidity.

When selecting CYCLE mode, use the sliders to set your CYCLE ON and CYCLE OFF timers.

When selecting Temperature and Humidity, use the sliders to select and the toggle switch to activate or deactivate them.

Tap CONFIRM to save the program.

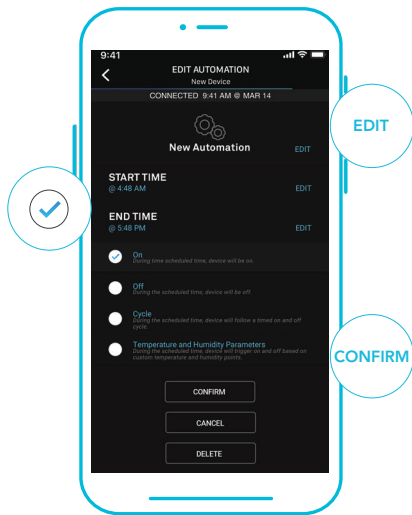

APP PROGRAMMING

ADVANCE PROGRAMMING - ALARMS

Alarms will tell your mobile device to beep once whenever your devices switches on or off as a result of the mode(s) you select in the program. Choose between AUTO, TIMER TO ON, TIMER TO OFF, CYCLE and SCHEDULE modes. Alarm programming will also have a climate points setting in which the alarm on the controller 69 will go on when temperature and humidity hits a high or low point.

2

Tap the (+) button to create an alarm program. You may select multiple modes to trigger an alarm in a single program.

When selecting Temperature and Humidity, use the sliders to select and the toggle switch to activate or deactivate them.

You may edit the name of the program by tapping EDIT.

Tap CONFIRM to save the program.

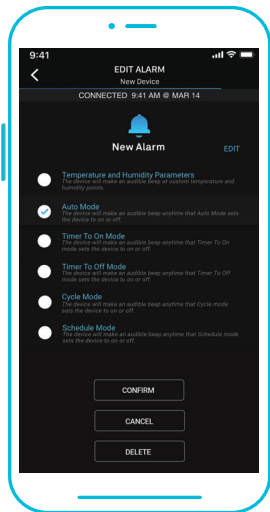

APP PROGRAMMING

ADVANCE PROGRAMMING - NOTIFICATIONS

Notification programs will send push notifications to your mobile device whenever your fan switches on or off as a result of the mode(s) you select in the program. Choose between AUTO, TIMER TO ON, TIMER TO OFF, CYCLE and SCHEDULE modes.

Notification programming will also have a climate points setting in which you receive push notifications when temperature and humidity hits a high or low point.

3

Tap the (+) button to create a notification program. You may select multiple modes to trigger an alarm in a single program.

When selecting Temperature and Humidity, use the sliders to select and the toggle switch to activate or deactivate them.

You may edit the name of the program by tapping EDIT.

Tap CONFIRM to save the program.

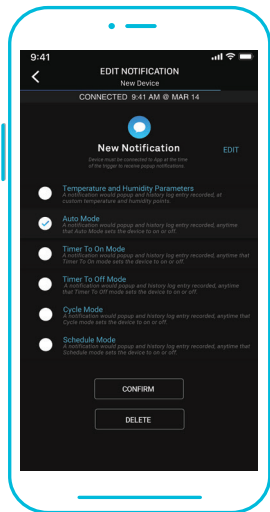

APP PROGRAMMING

DATA TAB

Logs and stores all temperature and humidity information. Readings are displayed in fluctuation charts and bar graphs and can be viewed in hours, days, weeks, months, and years. Data can be exported as a spreadsheet and sent to other devices by tapping EXPORT CSV DATA.

1

The Fluctuation Charts readout displays the detected temperature or humidity over a given timespan. Swipe left or right to scroll through the readings. As you scroll, the dotted line will move up or down and display the average reading of the timespan you selected.

The maximum reading of the given time span is displayed at the top of the chart, while the minimum reading is displayed at the bottom of the chart.

Toggle to the numbered port view to see a single device's status and temperature/humidity over a given timespan.

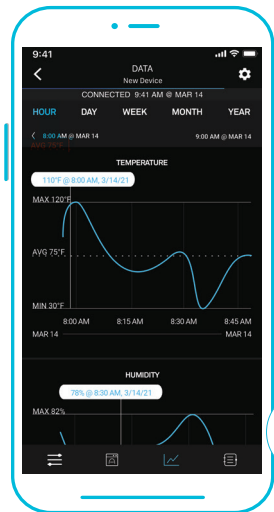

APP PROGRAMMING

DATA TAB

The fluctuation charts and bar graphs allow you to see trends in temperature and humidity and enable you to make the necessary adjustments to your space. Tap on any point in the charts and graphs to see detailed information on the picket.

2

Bar Graphs - This readout displays how often a detected temperature or humidity point occurs over a given timespan.

The minimum and maximum readings of the given timespan are displayed at the top of the graph.



APP PROGRAMMING

HISTORY LOG

Logs all advance programming notifications and controller activity. Entries can be filtered by controller functions and programming including triggers, timers, cycles, schedules, automation, alarms, and notifications.

1

Swipe up and down to scroll through the history log.



2

Tap SHOW FILTERS to reveal activity options. Unchecked functions will filter them from the log.

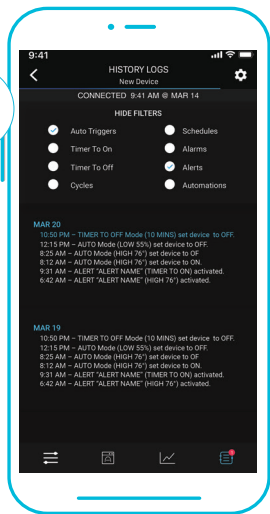

APP SETTINGS

SETTINGS

Tap the gear icon  on the top right corner to access the settings. Sets all controller-related parameters including Device Name, Temperature Display, Screen Brightness, Transitions, and Calibrations. Tap CONFIRM to save your settings. Tapping CANCEL will leave the settings menu without saving changes. Tapping DELETE DEVICE will unpair your controller from the app.

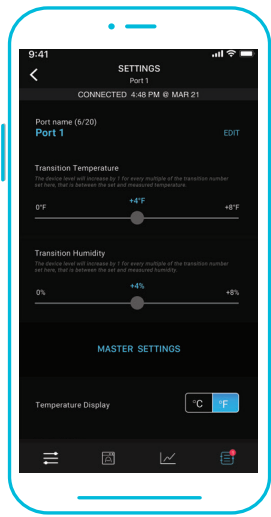

APP SETTINGS

SETTINGS

Tap the gear icon to access the settings. Sets all controller-related parameters including Device Name, Temperature Display, Screen Brightness, Transitions, and Calibrations. Tap CONFIRM to save your settings. Tapping CANCEL will leave the settings menu without saving changes. Tapping DELETE DEVICE will unpair your controller from the app.

DEVICE NAME

Supports a maximum of 20 characters.

TEMPERATURE DISPLAY

Toggles between Celsius and Fahrenheit scales.

DEVICE BRIGHTNESS

Sets the controller screen brightness using three standard levels [1, 2, and 3] and two auto-dimming levels [A2 and A3].

TRANSITION TEMPERATURE AND HUMIDITY

Adjusts the degree to which the level steps up or down. The level will change by one for every multiple of this transition setting between the set and current climate condition in MASTER CONTROL settings or each individual port settings.

CALIBRATION TEMPERATURE AND HUMIDITY

Adjusts the controller's temperature and humidity readings to match your other measuring device's readings. The calibration will apply the changes on the app and the controller.

CONTROLLER 69 FAQ

Q: Where is the best place to position the sensor probe?

A: Place the sensor probe as close as possible to the hottest or most humid spot in your space.

Q: Do I need to remove the plastic cap from the probe?

A: Yes. You will need to remove the plastic cap so the probe can accurately read climate conditions.

Q: Can I connect different sized fans to the same controller?

A: Please refer to page 12 for details on adding more fan units.

Q: Will I be able to use this controller with my own fan?

A: The CONTROLLER 69 is only compatible with AC Infinity fans that use EC-motors.

Q: Does the controller retain its settings after power is shut off?

A: Yes. If the controller's power is cut off and is powered on afterwards, your settings will remain.

Q: My controller isn't pairing with the app. How do I fix this?

A: If the pairing process isn't successful, turn off your Bluetooth and reenable it to try again. When starting the pairing process around multiple Bluetooth controllers, move your smart device closer to the controller you wish to connect the app with.

AC INFINITY PRODUCTS

Advance Grow Tents

The CLOUDLAB series is a line of grow tents designed to create ideal growing conditions and facilitate indoor plant cultivation year-round. Features 2000D thick oxford canvas lined with inner diamond patterned mylar that maximizes grow light luminosity, and a reinforced frame with 150 lb. weight capacity. Includes a mounting plate to install your AC Infinity controller onto.

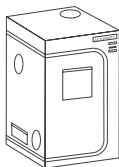

Inline Duct Fans

The CLOUDLINE series is a line of duct fans designed to quietly ventilate AV rooms and closets, as well as various DIY air circulation and exhaust projects. Features a thermal controller with intelligent programming that will automatically adjust duct fan speeds in response to changing temperatures.

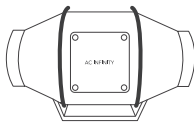

Grow Lights

An indoor LED grow lamp designed to simulate outdoor daytime lighting to improve and accelerate your plant's photosynthesis. Using the latest Samsung LM301H diodes, this LED grow system efficiently produces full-spectrum lighting usable during all stages of the grow cycle.



Discover the latest innovations in cooling and ventilation at acinfinity.com

WARRANTY

This warranty program is our commitment to you, the product sold by AC Infinity will be free from defects in manufacturing for a period of two years from the date of purchase. If a product is found to have a defect in material or workmanship, we will take the appropriate actions defined in this warranty to resolve any issues.

The warranty program applies to any order, purchase, receipt, or use of any products sold by AC Infinity or our authorized dealerships. The program covers products that have become defective, malfunctioned, or expressively if the product becomes unusable. The warranty program goes into effect on the date of purchase. The program will expire two years from the date of purchase. If your product becomes defective during that period, AC Infinity will replace your product with a new one or issue you a full refund.

The warranty program does not cover abuse or misuse. This includes physical damage, submersion of the product in water, incorrect installation such as wrong voltage input, and misuse for any reason other than intended purposes. AC Infinity is not responsible for consequential loss or incidental damages of any nature caused by the product. We will not warrant damage from normal wear such as scratches and dings.

To initiate a product warranty claim, please contact our customer service team at support@acinfinity.com



If you have any issues with this product, contact us and we'll happily resolve your problem or issue a full refund!

COPYRIGHT © 2021 AC INFINITY INC. ALL RIGHTS RESERVED

No part of the materials including graphics or logos available in this booklet may be copied, photocopied, reproduced, translated or reduced to any electronic medium or machine readable form, in whole or in part, without specific permission from AC Infinity Inc.

www.acinfinity.com