

AC INFINITY

CLOUDRAY

CIRCULATION FAN SYSTEM

USER MANUAL

WELCOME

Thank you for choosing AC Infinity. We are committed to product quality and friendly customer service. If you have any questions or suggestions, please don't hesitate to [contact](#) us. Visit www.acinfinity.com and click contact for our contact information.

EMAIL

support@acinfinity.com

WEB

www.acinfinity.com

LOCATION

Los Angeles, CA

MANUAL CODE CC2208X1

PRODUCT

CLOUDRAY A6
CLOUDRAY S6
CLOUDRAY T6
CLOUDRAY A9
CLOUDRAY S9
CLOUDRAY T9

MODEL

AC-CCA6
AC-CCS6
AC-CCT6
AC-CCA9
AC-CCS9
AC-CCT9

UPC-A

819137022416
819137022423
819137022447
819137022454
819137022461
819137022478

MANUAL INDEX

Manual Index	Page 5
Product Warning	Page 6
Recommended Usage	Page 7
Key Features	Page 8
Product Contents	Page 9
Installation	Page 10
Powering and Setup	Page 12
Cleaning	Page 13
AC Infinity Grow System	Page 15
Connecting to Controllers	Page 16
Programming	Page 17
Frequently Asked Questions	Page 19
Other AC Infinity Products	Page 20
Warranty	Page 21

PRODUCT WARNING



TO REDUCE THE RISK OF FIRE, ELECTRIC SHOCK, OR INJURY TO PERSONS,
OBSERVE THE FOLLOWING:

1. Ensure your power source conforms to the electrical requirements of this product.
2. Check your local code restrictions for additional safety measures that may be needed for a proper code compliant installation.
3. Read all instructions before installing and using this product.
4. If you are unfamiliar or have doubts about performing this product's installation, seek the services of a qualified, trained, and licensed professional. Inappropriate installation will void this product's warranty.
5. This product must not be used in potentially hazardous locations such as flammable, explosive, chemical-laden or wet atmospheres.
6. Do not cover power cords with rugs or other fabric materials.
7. This product has rotating parts. Safety precautions should be exercised during the installation, operation, and maintenance of this product.
8. Do not insert or allow fingers or foreign objects to enter through the fan grille as it may cause electric shock, fire, or damage to this product. Do not block or tamper with this product in any manner while it is in operation.
9. Do not depend on the on/off programming as the sole means of shutting power from this product. Unplug the power cord before installing, servicing, or moving this product.
10. Do not operate this product while its cord is damaged, or if it malfunctions, has been dropped, or is damaged in any manner.

RECOMMENDED USAGE

REDUCING CORD TENSION

Please make sure to provide enough slack for the power cord and the extension cord. The fan should be able to oscillate freely without tugging on its cords.

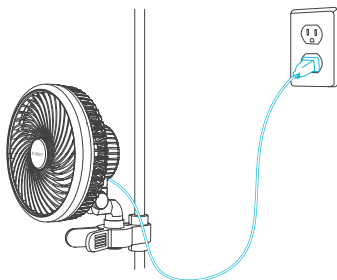

MAXIMIZING LIFESPAN

This fan utilizes the latest in step motor technology that allows it to operate 24 hours a day.

However, to maximize its lifespan, we do not recommend having it oscillate nonstop for more than 18 hours a day.

This will preserve the motor by passively keeping it cool to prevent it from wearing down.

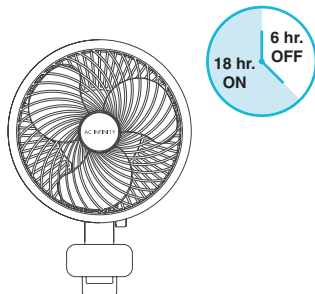

KEY FEATURES

EC MOTOR

Next generation motor runs quieter, is more energy efficient, and has a longer lifespan than AC motors.

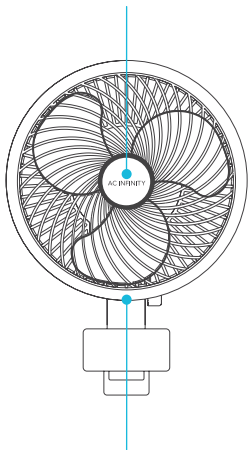

IP-44 PROTECTION

The clip fan is sealed to Ingress Protection 44 standards, rated with high resistance to liquids and dust.

PWM SPEED CONTROL

Digitally controlled to enable low speeds for gentler airflow while expanding maximum level range to ten fan speeds.

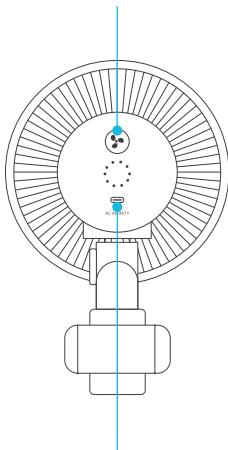

UIS™ COMPATIBLE

Connects with UIS controllers for temperature, humidity, timer, cycle, and schedule programming.

COMPACT BASE

Shallower motor base allows for closer mounting to poles to maximize amount of grow space.

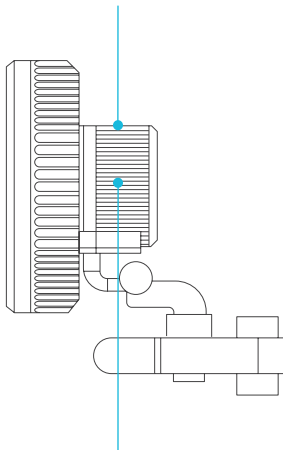

DUAL BALL BEARINGS

The motor contains ball bearings with an estimated 67,000 hour lifespan. Enables the fan to be mounted in any orientation.

A-Series model shown

PRODUCT CONTENTS

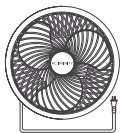

CIRCULATION
FAN
(x1)

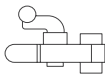

GRIP
CLIP
(x1)



ADAPTER
DONGLE
(x1)

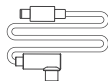

EXTENSION
CORD
(x1)



CABLE
TIE
(x4)

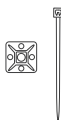

CABLE
MOUNT
(x1)

INSTALLATION

STEP 1

Twist to remove the bigger knob piece from the grip clip.

Pull the smaller button piece from the vice grip.

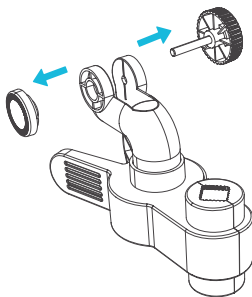

STEP 2

Slide the grip clip into the swivel.

You may need to pull its clamps apart for it to fit over the swivel. This tightness ensures your fan will not tilt downwards on its own.

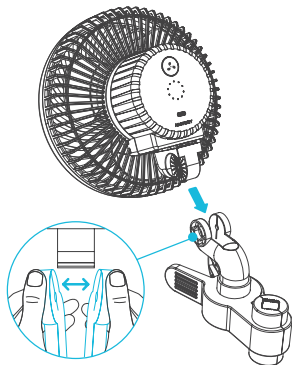

INSTALLATION

STEP 3

Replace the knob and button on either side of the mounting point as desired.

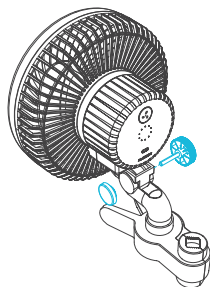

STEP 4

Clamp your clip fan onto a pole or post.

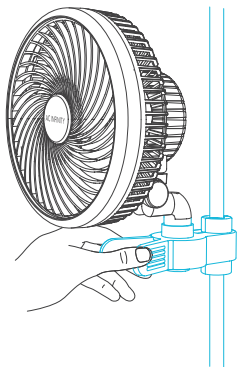

POWERING AND SETUP

STEP 1

Plug your clip fan's power cord into an AC power outlet to power it.

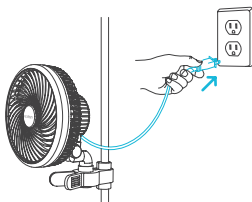

STEP 2

You may cable manage the cords using the included cable ties or cable mounting set.

Adhere the tie mount onto a clean surface. Loop the zip tie into the mount and around the cables.

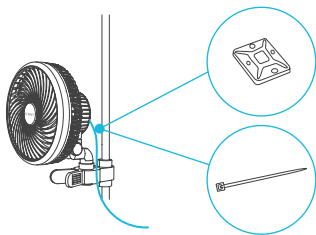

CLEANING

STEP 1

Unplug your clip fan.

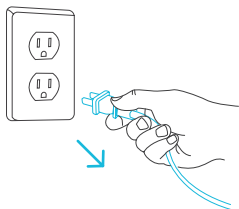

STEP 2

Remove the front grille by twisting the grille counter-clockwise and pulling it off.

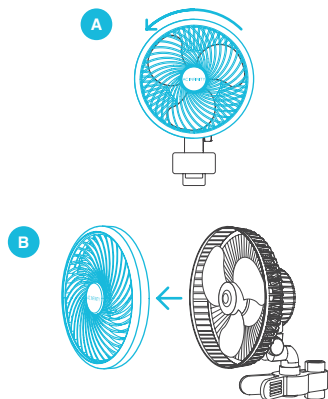

Removing the front grille to clean the fan blades will not void your warranty.

CLEANING

STEP 3

Wipe off any dust and debris from the grille and fan blades using a damp cloth. Set aside to dry as needed.

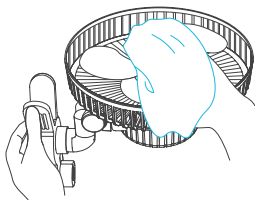

STEP 4

Realign the grille over your clip fan and twist clockwise to lock it in place.

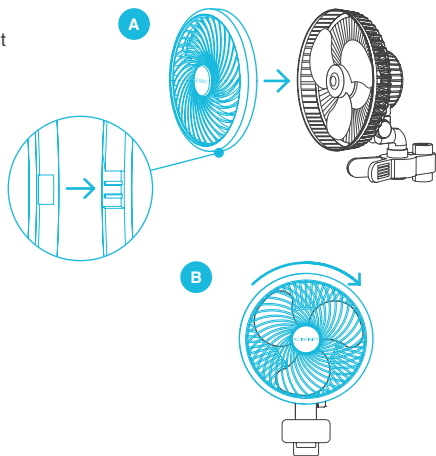

AC INFINITY GROW SYSTEM

AN INTERCONNECTED BUILD

The Universal Infinity System™ is a series of controllers and devices that come together to create a fully automated system. UIS™ enables our controllers to simultaneously connect with various grow equipment such as inline fans, clip-on fans, and grow lights.

Advance UIS™ controllers can provide each connected UIS™ device with their own automated programming like temperature, humidity, cycles, schedules, and dynamic levels, while also pairing with the AC Infinity app.

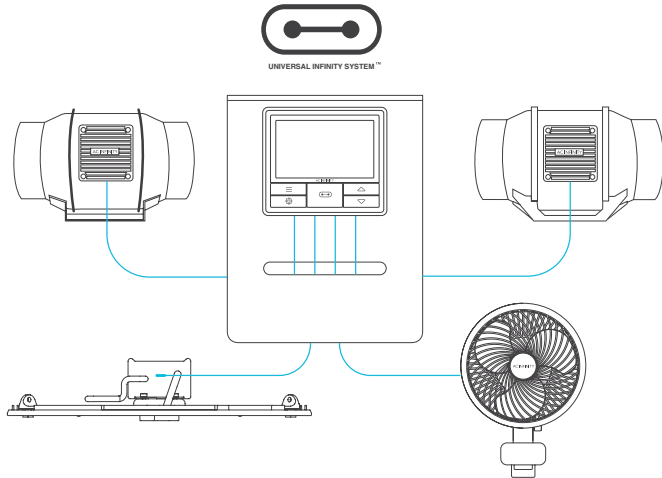

Central controllers and grow devices will be sold separately and may still be in development at the time of your purchase of this product.

CONNECTING TO CONTROLLERS

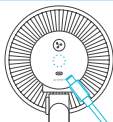

The CLOUDRAY circulation fan can connect with select smart controllers as part of an integrated system using the included UIS cable. [Please see below for limitations.](#)

UIS™ CONNECTORS

To connect to the latest gen controllers such as CONTROLLER 69 (sold separately), use the included UIS extension cord to directly connect the CLOUDRAY fan's UIS port to the controller's UIS port.

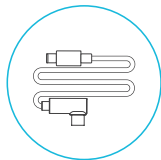
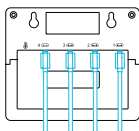

MOLEX CONNECTORS

To connect to previous gen controllers such T-Series controller (UNC529) or CONTROLLER 67 (sold separately), use the included adapter dongle to convert the controller's molex connector to a UIS connector. Then use the included UIS extension cord to connect that to the CLOUDRAY fan's UIS port.

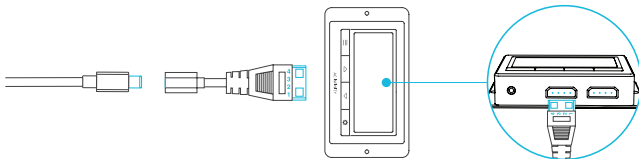

Shown: CONTROLLER 67

PROGRAMMING

A-SERIES

FAN SPEED ADJUSTING

Your clip fan features a single button that cycles through the fan speed from 0-10, indicated by the ring of LED lights below.

Press the speed button to increase the fan speed level by one.

Pressing the button past speed 10 will cycle the fan speed back to 0.

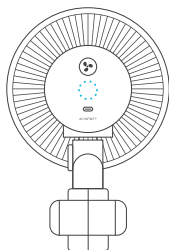

Fan Speed Indicator

POWERING ON/OFF

Hold the speed button for 4 seconds to turn the fan OFF. Pressing it again from OFF will turn the fan ON at its last speed setting.

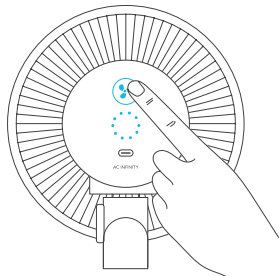

PROGRAMMING

S-SERIES

OSCILLATION

In addition to the standard features, S-Series models can oscillate to provide airflow at a wider angle.

Press the swivel button to activate your clip fan's oscillation.

The oscillation function is manually activated using the button as indicated here and cannot be controlled using external UIS programming.

If set to off, your clip fan will not oscillate regardless of any external programs.

If set to on, oscillation will automatically start if the external program activates your clip fan to turn ON. Oscillation will then automatically stop if the external program deactivates your clip fan to turn OFF.

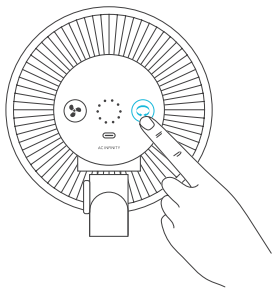

Leaving the oscillation activated for more than 24 hours at a time may reduce the lifespan of your clip fan.

CLOUDRAY FAQ

Q: Can I mount this clip fan upside down?

A: Yes. The CLOUDRAY can be mounted rightside up or upside down.

Q: Will I be able to hardwire this clip fan to my own controller or thermostat?

A: We do not recommend hardwiring or splicing our fan's power wires. Such modifications may compromise electrical safety and will void this product's warranty.

Q: Do I need to use a power converter if I'm outside the US?

A: This product's voltage range is 100-240V AC. You may need a simple travel adapter to plug it into a foreign socket, or a power converter if your country uses a different voltage.

Q: What is the CFM of my clip fan?

A: Please refer to your CLOUDRAY model's product listing for its CFM specification.

Q: Will the clamp be able to hold onto my grow tent?

A: The heavy-duty clamp is capable of gripping onto the poles of any thickness in any grow tent.

Q: Will I be able to connect additional units to this clip fan?

A: The CLOUDRAY does not support daisy chaining or interconnectivity between additional clip fans. However, multiple fans can be connected to a UIS™ controller to receive smart programming.

Q: How long can I keep this clip fan running?

A: The CLOUDRAY features the latest innovations in step motor technology, allowing it to run continuously for 24 hours a day.

AC INFINITY PRODUCTS

Inline Duct Fans

The CLOUDLINE series is a line of duct fans designed to quietly ventilate AV rooms and closets, as well as various DIY air circulation and exhaust projects. Features a thermal controller with intelligent programming that will automatically adjust duct fan speeds in response to changing temperatures.

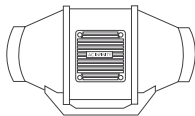

Carbon Filters

The duct carbon filter is designed to eliminate odors and chemicals for grow tents and hydroponic spaces. It utilizes premium grade Australian charcoal that features greater absorption power and a longer lifespan. Enables maximum airflow pass through as part of an intake or an exhaust system.

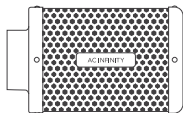

Grow Lights

An indoor LED grow lamp designed to simulate outdoor daytime lighting to improve and accelerate your plant's photosynthesis. Using the latest Samsung LM301H diodes, this LED grow system efficiently produces full-spectrum lighting usable during all stages of the grow cycle.

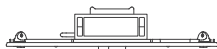

Discover the latest innovations in environmental controls at acinfinity.com

WARRANTY

This warranty program is our commitment to you, the product sold by AC Infinity will be free from defects in manufacturing for a period of two years from the date of purchase. If a product is found to have a defect in material or workmanship, we will take the appropriate actions defined in this warranty to resolve any issues.

The warranty program applies to any order, purchase, receipt, or use of any products sold by AC Infinity or our authorized dealerships. The program covers products that have become defective, malfunctioned, or expressly if the product becomes unusable. The warranty program goes into effect on the date of purchase. The program will expire two years from the date of purchase. If your product becomes defective during that period, AC Infinity will replace your product with a new one or issue you a full refund.

The warranty program does not cover abuse or misuse. This includes physical damage, submersion of the product in water, incorrect installation such as wrong voltage input, and misuse for any reason other than intended purposes. AC Infinity is not responsible for consequential loss or incidental damages of any nature caused by the product. We will not warrant damage from normal wear such as scratches and dings.

Contact our dealers department at dealers@acinfinity.com or (626) 838-4656 for more information about our dealers and distributors program. Contact our customer service department at support@acinfinity.com or 626-923-6399 for product and warranty assistance. Our business hours are Monday through Friday, 9:00 am to 5:00 pm PST.



If you have any issues with this product, contact us and we'll happily resolve your problem or issue a full refund!

COPYRIGHT © 2022 AC INFINITY INC. ALL RIGHTS RESERVED

No part of the materials including graphics or logos available in this booklet may be copied, photocopied, reproduced, translated or reduced to any electronic medium or machine readable form, in whole or in part, without specific permission from AC Infinity Inc.

www.acinfinity.com